



AIDA

Capella Model description

MOISE project

Open source documentation



Shortcuts			
1	2 SA	3 LA	4 PA

Table of content

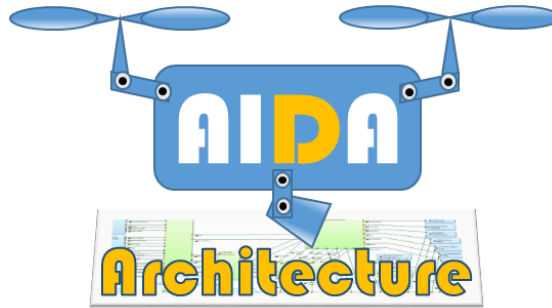

- 0 Before opening the Capella model
- 1 Capella model overview
- 2 SA: System Need Analysis layer/vision description
- 3 LA: Logical architecture layer/vision description
- 4 PA: Physical architecture layer/vision description

Tip: *activate shortcuts in diaporama*

Copyright (c) 2016-2018 IRT AESE (IRT Saint Exupéry).

All rights reserved. This program and the accompanying materials are made available under the terms of the

Creative Commons Attribution-ShareAlike 4.0 International (CC BY-SA 4.0)

which accompanies this distribution, and is available at

<https://creativecommons.org/licenses/by-sa/4.0/>

Contributors:

Pierre Virelizier, Tatiana Prosvirnova, Estelle Saez – Initial contribution

Shortcuts			
1	2	3	4
	SA	LA	PA

Capella tool

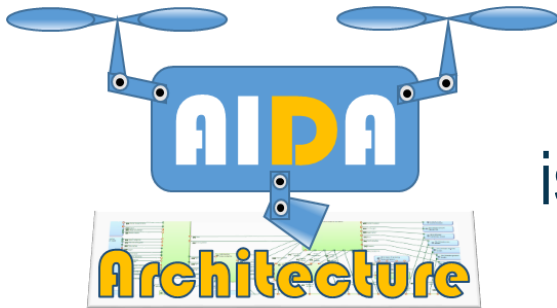

is modelled with  **Capella**

(Tool version is described in the readme file)

Capella is an Open Source MBSE tool (Model Based System Engineering). This tool implements the Arcadia method.

The following site provides all the information requested about both the tool and the method:

<https://www.polarsys.org/capella/>

AIDA system introduction

- AIDA (Aircraft Inspection by Drone Assistant)
- Assistance during walk around. AIDA seeks Aircraft defects.

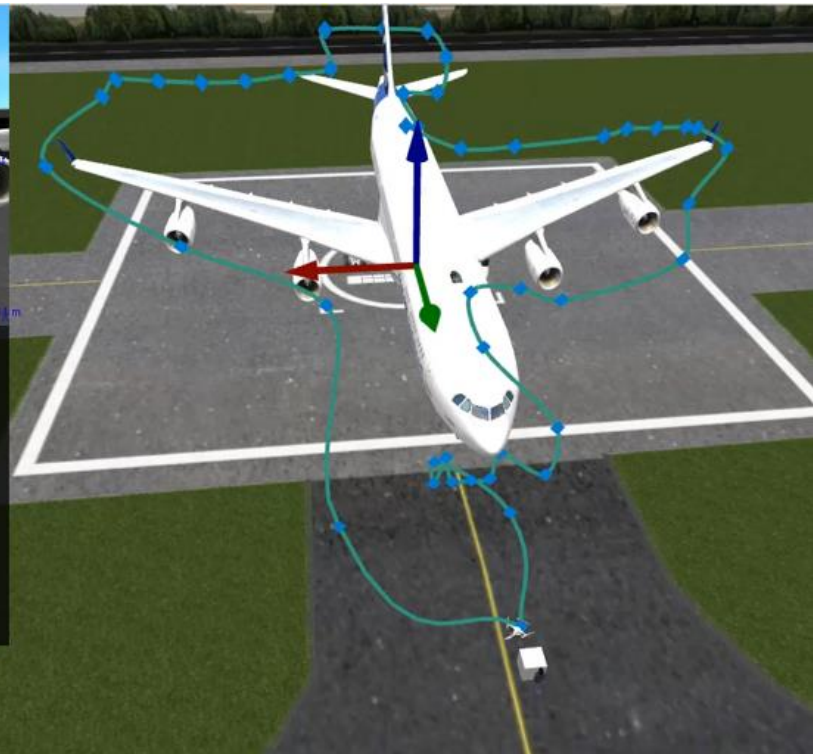

Shortcuts			
1	2 SA	3 LA	4 PA

AIDA system description

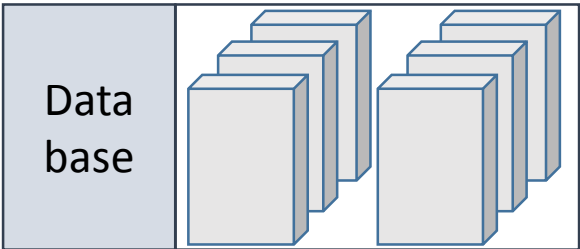
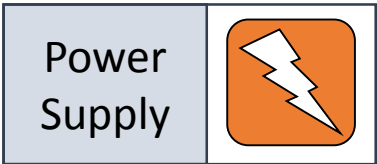
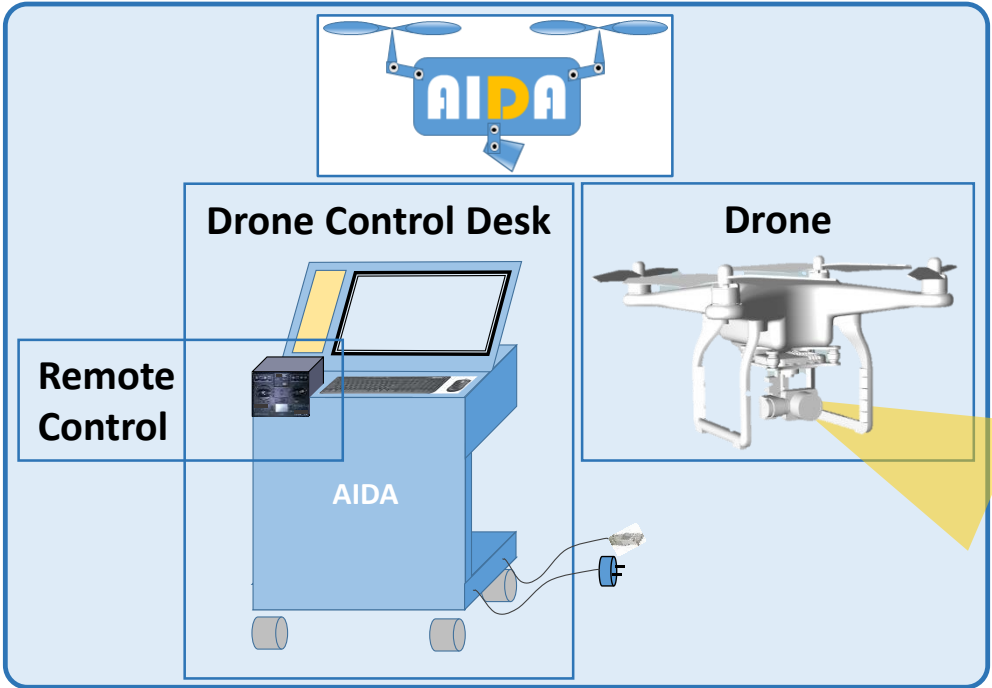
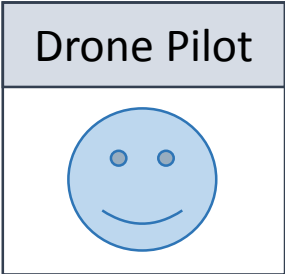

AIDA experimentation

- AIDA system was designed and modelled by the MOISE project (IRT Saint Exupéry, Toulouse, France).
- This system is a full study case, covering several fields of system design assisted by models.



Architecture

Topics: system architecture, MBSE
Tool: Capella



Safety

Topics: system safety analysis, MBSA, Altarica
Tool: Cecilia Ocas



Simulation

Topics: system simulation, control law, cosimulation
Tools: simulationX, OpenModelica, ProSivic, Cosimate

- This document describes the model of the **AIDA Architecture** package.

Shortcuts			
1	2 SA	3 LA	4 PA

Table of content

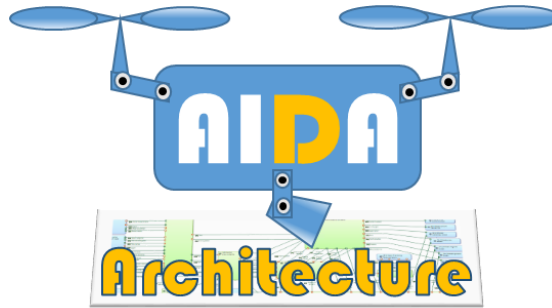







- 0 Before opening the Capella model
- 1 Capella model overview
- 2 SA: System Need Analysis layer/vision description
- 3 LA: Logical architecture layer/vision description
- 4 PA: Physical architecture layer/vision description

Tip: *activate shortcuts in diaporama*

Capella model overview

- **Important remark:** Only some parts of the Capella model are populated.
- The selection of objects, diagrams and visions is not justified in this document.

Capella layers/visions		 AIDA model description	
		Content	Comments
Arcadia note: Visions for environment description and need analysis.		Empty: not used	
		Vision with need analysis and system context analysis	Gathers technical exchanges between system supplier and customer
Arcadia note: Visions for solution description		Vision for classification and traceability between need analysis and solution	 Work Underway
		Vision with the solution of the system supplier (with functions of physical objects)	System supplier proposal

Shortcuts			
1	2 SA	3 LA	4 PA

Table of content

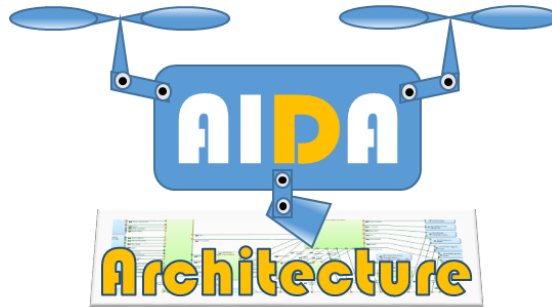

- 0 Before opening the Capella model
- 1 Capella model overview
- 2 SA: System Need Analysis layer/vision description
- 3 LA: Logical architecture layer/vision description
- 4 PA: Physical architecture layer/vision description

Tip: *activate shortcuts in diaporama*

SA layer description (1/2)

- Viewpoints and main objects used in the AIDA model

 Viewpoints	Capella diagrams	Capella Objects	Folder
VP Actors identification	CSA	Actors	./AIDA
VP System environment	SAB & SDFB	Funct. exchange Comp. exchange Physical link	./AIDA ./System Functions
VP System detailed external interface	SDFB	Exchanged item Funct. exchange	./System Functions
VP External interface scenario	ES		./Capabilities/External interface scenarios
VP External interface modes	MSM	Mode	./AIDA/External interface modes
VP Lifecycle	MSM	State	./AIDA/Lifecycle
VP Internal modes	MSM	Mode	./AIDA/Internal modes
VP Mission	MCB	Mission and capability	./Capabilities ./Missions
VP Scenario	ES		./Capabilities (attached to capability)

SA layer description (2/2)

- The AIDA system need analysis outcome is:
 - A list of [EF] Expected functions
 - An expected interface defined by: [EFI] Expected functional interface & component exchanges & physical links
 - A list of [EM] Expected modes
 - Actors description: list of actors
- Traceability: AIDA model experiments the ability to ensure a full traceability of those object between SA (context analysis) and PA (solution)

Shortcuts			
1	2 SA	3 LA	4 PA

Table of content

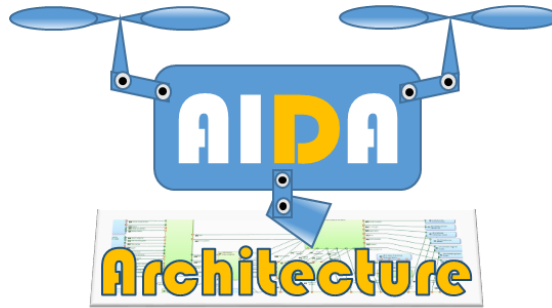

- 0 Before opening the Capella model
- 1 Capella model overview
- 2 SA: System Need Analysis layer/vision description
- 3 LA: Logical architecture layer/vision description
- 4 PA: Physical architecture layer/vision description

Tip: *activate shortcuts in diaporama*

LA layer description (1/3)



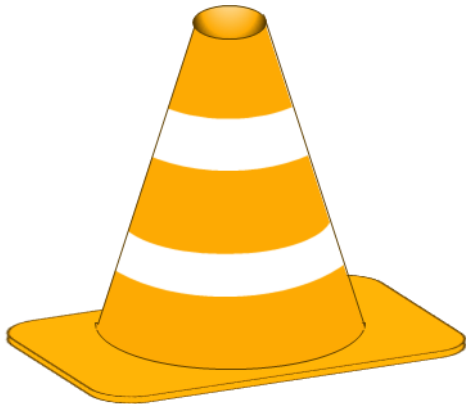

- In the AIDA model, this layer is used to ease traceability between SA (context analysis) and PA (solution).



Work underway:
This part of the model is not finalized.
(Some inconsistency might still remain)

LA layer description (2/3)

- Mains corresponding Capella objects throughout the visions

	Actor	System interface	Function	Mode
	Actor	<i>Exchanged item</i> Funct. exchange <i>Comp. exchange</i> Physical link	System function	Mode
	Logical actor	Funct. exchange Physical link	Logical function	Mode
	Physical actor	Funct. exchange Physical link	Physical function	Mode

Shortcuts			
1	2 SA	3 LA	4 PA

LA layer description (3/3)

- In the AIDA model, LA layer is a step dedicated to traceability between context analysis (performed with system customer) and solution description.
- There are two main concerns:
 1. Ensuring **consistency of the system environment model**.
 - Actor traceability
 2. Ensuring that the **solution meets the expectations defined with the customer**
 - **System interface** traceability: ensures that all the expected flows and exchanges are supported by the proposed system solution
 - **Functions** traceability: ensures that all the expected functions are fulfilled by the functions (or components) of the proposed system solution
 - **Modes** traceability: ensures that the expected modes are fulfilled by modes of the proposed system solution

Shortcuts			
1	2	3	4
	SA	LA	PA

Table of content

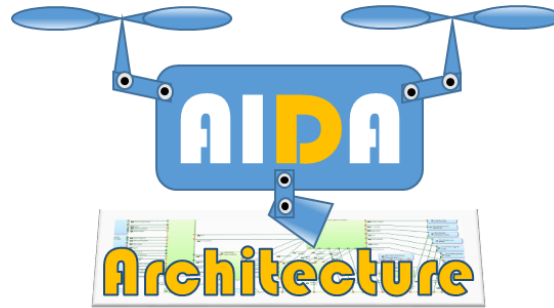

- 0** Before opening the Capella model
- 1** Capella model overview
- 2** SA: System Need Analysis layer/vision description
- 3** LA: Logical architecture layer/vision description
- 4** PA: Physical architecture layer/vision description

Tip: *activate shortcuts in diaporama*

PA layer description (1/6)

Physical architecture: main objects

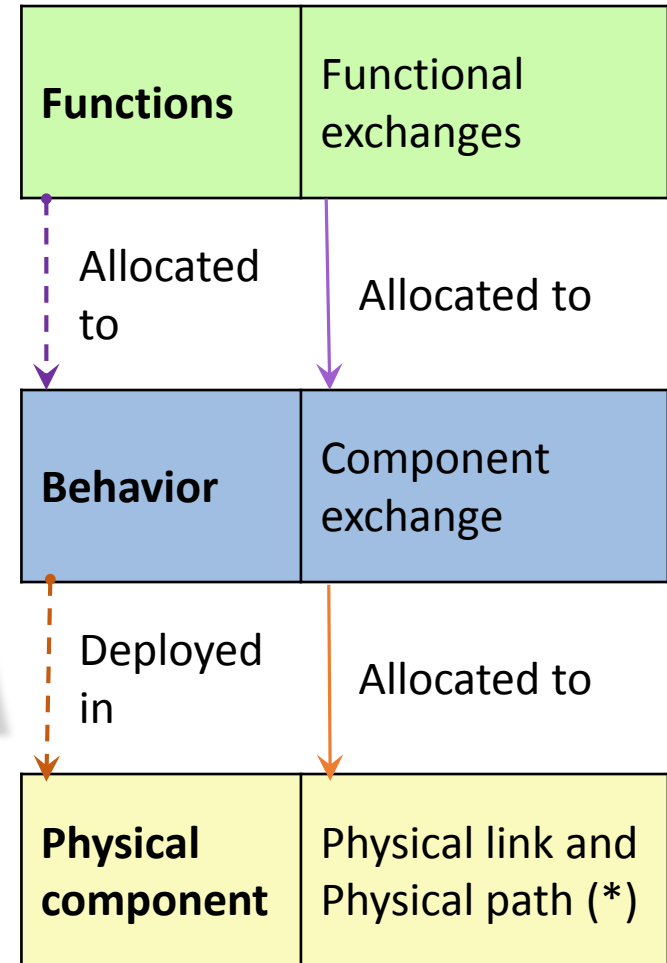
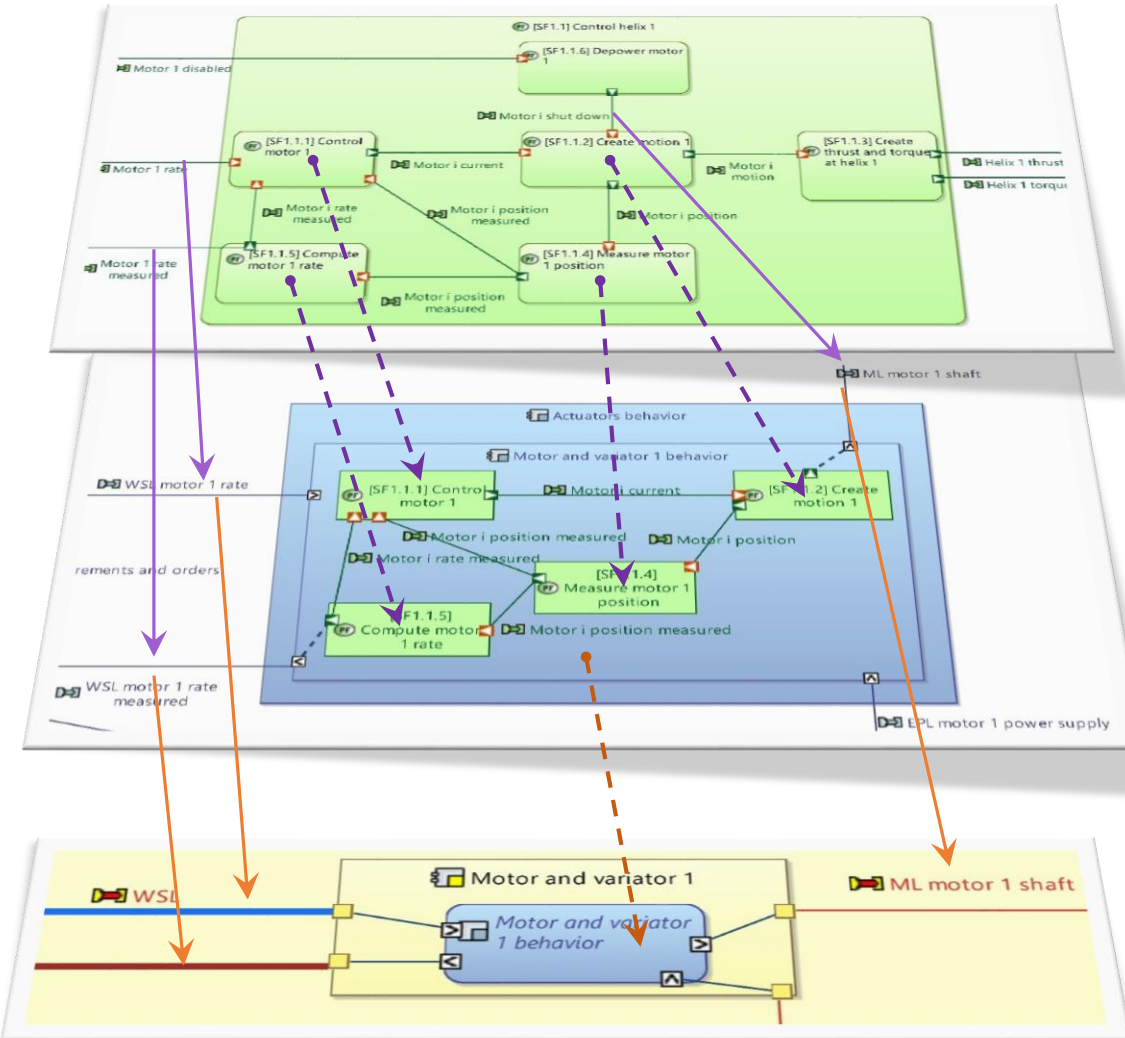

PA layer description (2/6)

- Names and location of the main diagrams of the physical architecture

Object	Functions	Behavior	Physical component
Where?	./Physical Function/	./Physical System/	./Physical System/
Breakdown	[PFBD] [...]	[PCBD] Breakdown of behavior components	[PCBD] Breakdown of physical components
Allocation / Deployment	[PAB] Functional allocation of [...]	[PAB] Behavioral deployment of [...]	
Links and exchanges	./Physical Function/ [PDFB] Functional Flows [...]	[PAB] Behavior components of [...]	[PAB] Physical components of [...]

- The PA layer also contains diagrams dedicated to exchanges with specialists:
 - [PDFB] Functional Flows Position and speed control loops
=> Exhibits the drone control loops (for Control law specialist)
 - [PAB] Physical components. Zonal view: [...]
=> Sketch for zonal analysis (for Safety analyst)

Names and conventions for **physical functions**

- All the physical functions have a **prefix** that depends on their allocation:

Prefix	Physical function allocated to
[SF n.m.p]	AIDA System
[Env]	Physical actor: Drone Environment
[Pos]	Physical actor: Positioning System
[A/C]	Physical actor: Aircraft
[Pil]	Physical actor: Drone pilot
[DB]	Physical actor: Data base

- “**n.m.p**” is a unique identification number with up to three numbers (functional level)
 - “**n**” => upper functional level
 - “**m**” => intermediate functional level
 - “**p**” => lower functional level

PA layer description (4/6)

Names and conventions for physical behavior

- All the leaf physical behavior were named after the deploying physical components: Name = “Physical constituent name” & “behavior”
- All the high level and mid level physical behaviors were only created for classification purpose.
 - They don't play any part, neither in the functional allocation nor in the physical deployment.
 - They were mainly classified and named after the corresponding physical component. But not always, as shown with the example of the monitoring channel

In behavior domain:

- ▶ COM Sensors behavior
 - ▶ Position sensor behavior
 - ▶ Magnetometer behavior
 - ▶ Lateral speed camera behavior
 - ▶ Telemetric sensor behavior
 - ▶ Inertial reference sensors behavior
 - ▶ Pressure sensor behavior
- ▶ MON Sensors and computers behavior
 - ▶ Inertial reference sensors MON behavior
 - ▶ Magnetometer MON behavior
 - ▶ Pressure sensor MON behavior
 - ▶ Telemetric sensor MON behavior
 - ▶ Monitoring processor behavior

Classification by monitoring channel

In physical domain:

- ▶ Computers
 - ▶ Main processor
 - ▶ Monitoring processor
 - ▶ Video processor
- ▶ Sensors
 - ▶ Inertial reference sensors
 - ▶ Magnetometer
 - ▶ Pressure sensor
 - ▶ Position sensor
 - ▶ Telemetric sensor
 - ▶ Telemetric sensor MON
 - ▶ Lateral speed camera
 - ▶ Inertial reference sensors MON
 - ▶ Magnetometer MON
 - ▶ Pressure sensor MON

Classification by product kind

Names and conventions for physical links

- All the physical links names have a **prefix** that depends on their physical type:

	Prefix	Physical link type
1	ML	Mechanical link
2	SL	Signal link
2.1	WSL	Wired signal link
2.2	USL	Unwired signal link
3	EPL	Electrical power link
4	FPL	Fluidic power link
5	FL	Fluid link
6	HMIL	Human Machine Interface link
7	PPL	Physical phenomenon link
7.1	VL	View link

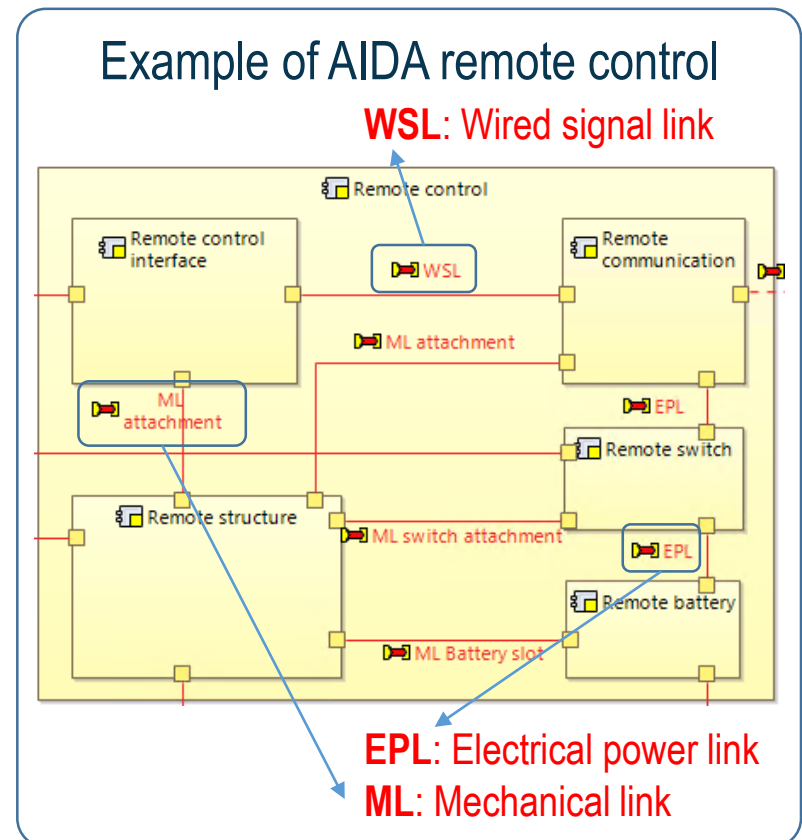

Unused in AIDA

PA layer description (6/6)

Physical components of the drone

View "All links together" => **useless**

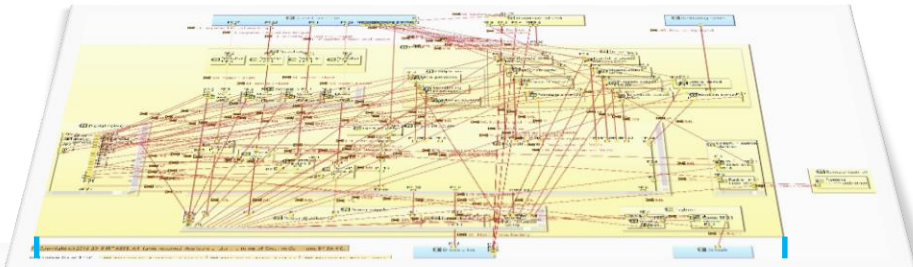

Signal links

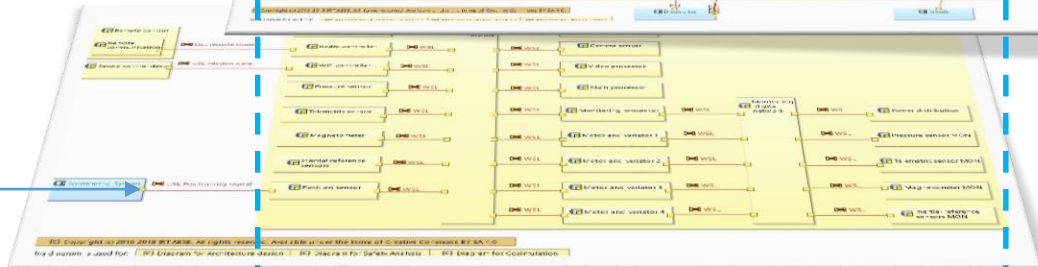

Electrical power links

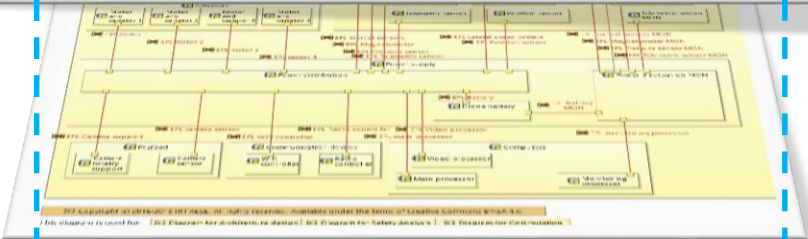

Mechanical, HMI and fluid links

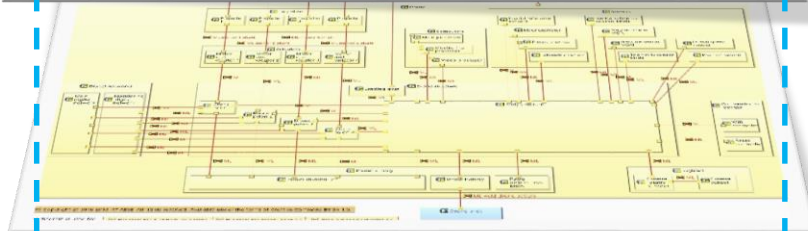

Physical phenomenon

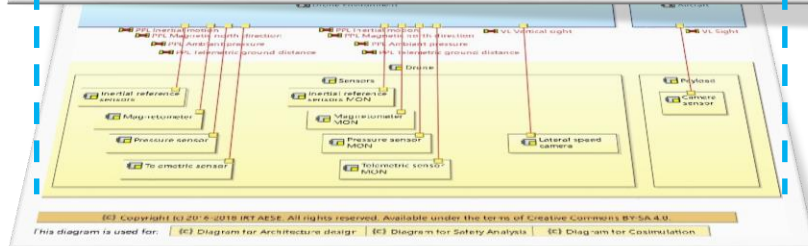

View in 4 clear layers

- We hope this package will be useful and relevant for your work. Please,
 - Provide us with your feedback about the model.
 - Share your experience with this package.

- What's next?
 - Help us define the future of this package.

